

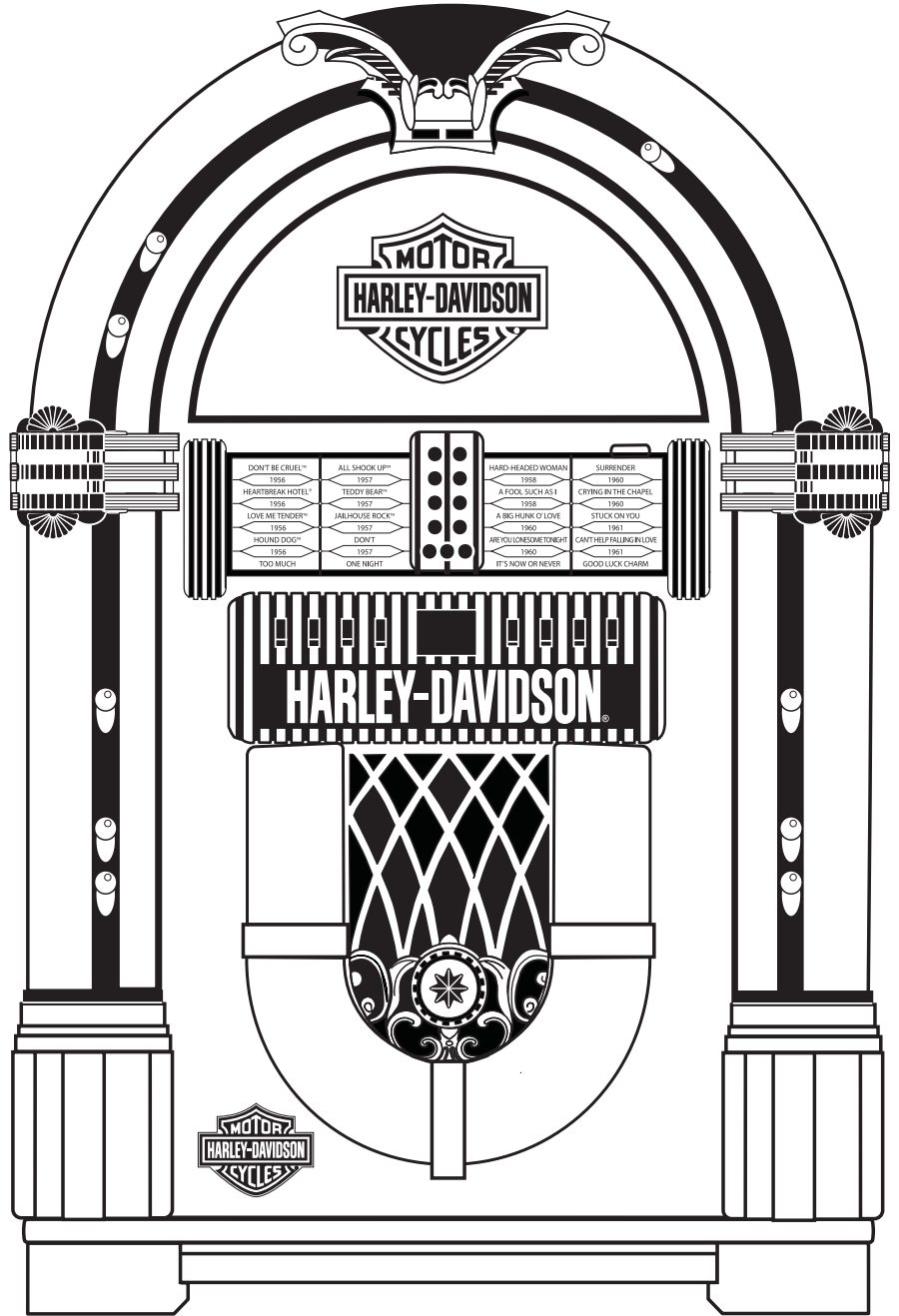

HD[®] MINI BUBBLER JUKEBOX INSTRUCTION MANUAL

Congratulations on your purchase of a Harley-Davidson[®] Mini Bubbler Jukebox. The utmost care has gone into the design and manufacturing of this product.

Before operating this unit, please read this manual thoroughly and retain it for future reference.



Features:

- Front Loading CD Player w/LED Display
- Programmable 20-Track Memory
- Repeat Play
- Decorative Musical Play List
- FM Radio with Analog Tuner
- Portable Audio Ready - Simply Plug in Your Portable Audio Device or MP3 Player with the supplied universal cable.
(designed to fit mini-pin headphone outputs.)
- Dynamic Full Range Stereo Speakers
- Electronically Assisted Tuner
- External FM Antenna
- External Speaker Outputs
- Full Function Remote Control with Hidden Storage
- Dimensions: 19" (H) X 12" (W) X 9.5" (D)



The lightning flash with arrowhead symbol, within an equilateral triangle, is intended to alert user to the presence of uninsulated "dangerous voltage" within the product's enclosure that may be of sufficient magnitude to constitute risk of electric shock to persons.

CAUTION

RISK OF ELECTRIC SHOCK DO NOT OPEN

CAUTION: TO REDUCE THE RISK OF ELECTRIC SHOCK, DO NOT REMOVE COVER (OR BACK). NO USER - SERVICEABLE PARTS INSIDE. REFER SERVICING TO QUALIFIED SERVICE PERSONNEL.



The exclamation point within an equilateral triangle is intended to alert user to the presence of important operating and maintenance (servicing) instruction in the literature accompanying the appliance.

Unit Controls

- 1 FM Tuner
- 2 Tuning
- 3 Light On / Off
- 4 Power On / Stand By
- 5 Program Indicator
- 6 Repeat Indicator
- 7 Play / Pause Indicator
- 8 Mute Indicator
- 9 Remote Sensor
- 10 Stand By Indicator
- 11 Power Indicator
- 12 CD Drawer
- 13 Remote Holder
- 14 Speaker Int. & Ext.
- 15 Speaker Jacks
- 16 FM Antenna
- 17 A/C Power Cord
- 18 Line In Jack
- 19 Line In ON/OFF Switch

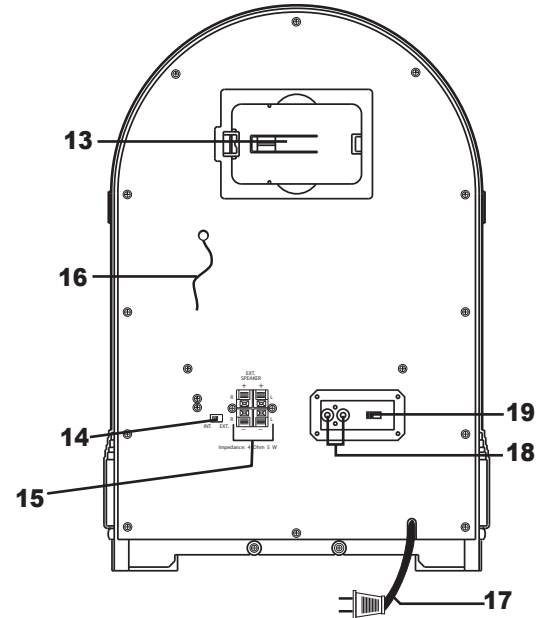
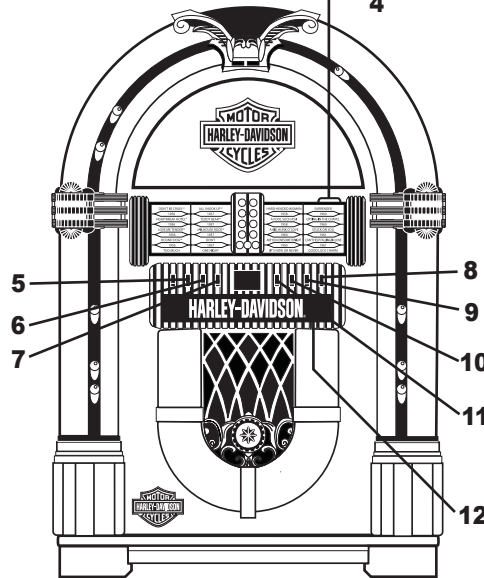
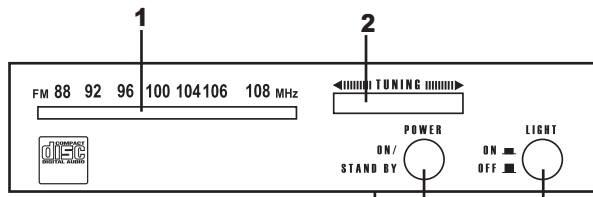

Unpacking

- 1 Remove packing materials from unit.
Note: Save all packing materials.
- 2 Remove plastic safety cover from A/C plug.
- 3 Remove tie from A/C cord
- 4 Open lid and remove styrofoam shipping material from turntable.

Basic Operation

Lights / Bubble Tubes

- 1 Gently pull on top right side of tuner door to open.
- 2 Push light button in to turn lights on.
- 3 Bubble tubes will begin to bubble in approximately 15-20 minutes after lights are turned on.
- 4 Bubble tubes will not bubble unless lights are on.

FM Stereo Operation

- 1 Turn power on using either the remote or power button located behind tuner door.
- 2 Push CD / RADIO BUTTON (25) to enable FM tuner.
- 3 Turn FM dial to desired station.
- 4 Position FM ANTENNA (16) for best reception.
- 5 Set volume to desired listening level.

CD Player

- 1 Make sure the power is on.
- 2 Push CD / RADIO BUTTON (25). The CD display will show (- -).
- 3 Push OPEN / CLOSE BUTTON (27) on remote to open CD DRAWER (12).
- 4 Insert CD in tray with the label side of CD facing up.
- 5 Push the OPEN / CLOSE BUTTON (27) again to close the CD DRAWER (12).
- 6 Push PLAY / PAUSE BUTTON (26) on remote to begin playing the CD.
- 7 To stop playing, push the STOP BUTTON (22) on remote.
- 8 To skip to different tracks, push the BACK SKIP (21) or FORWARD SKIP BUTTON (29) on the remote. The FORWARD SKIP BUTTON (29) will go numerically through tracks forward and the BACK SKIP BUTTON (21) will go backwards.
- 9 By pressing and holding either the BACK SKIP (21) or FORWARD SKIP BUTTON (29), you can rewind or fast forward through each individual track. The track will fast forward or rewind as long as you are holding the button. Once you let off the button, regular playback resumes.
- 10 During playback, you can use the REPEAT BUTTON (23) to repeat an individual song or the whole CD. While a song is playing, push the REPEAT BUTTON (23) on the remote. You will see the repeat light on the radio start flashing. This means that once the song is over, it will automatically start playing that song again. Pushing the REPEAT BUTTON (23) twice will make the repeat light come on without flashing. When the whole CD is finished, it will automatically start from the very beginning of the CD and play it again. Pushing the REPEAT BUTTON (23) once more will disable the repeat function and CD will stop playing at the end of the disc.

CAUTION

For Compact Disc Units Only:
INVISIBLE LASER RADIATION WHEN OPEN AND INTERLOCK FAILED OR DEFEATED. AVOID DIRECT EXPOSURE TO LASER BEAM.

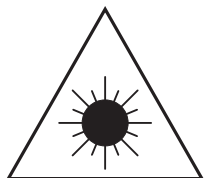

Remote Controls

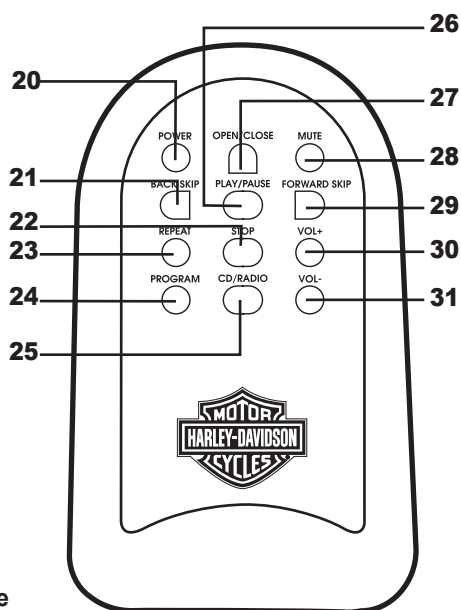

- 20 Power
- 21 Back Skip
- 22 Stop
- 23 Repeat
- 24 Program
- 25 CD / Radio
- 26 Play / Pause
- 27 Open / Close
- 28 Mute
- 29 Forward Skip
- 30 Volume Up
- 31 Volume Down

Remote Control

- 1 The remote controls both the radio and the CD player.
- 2 Use power button to turn unit on or off (standby).
- 3 Vol + (30) and Vol - (31) are used to raise or lower volume.
- 4 CD / RADIO BUTTON (25) switches between radio and CD operation.
- 5 The MUTE BUTTON (28) is used to mute volume completely.
- 6 The other remote functions are used for CD controls and will be discussed under CD operation.

Programmed CD Playback

The CD player in this unit is programmable. This means you can program it to play only selected tracks on the selected CD. Follow instruction below to program the CD player.

- 1 Insert disc and close CD DRAWER (12). Do not push play yet.
- 2 Push the PROGRAM BUTTON (24) on the remote. The program light on the radio will start flashing.
- 3 Use the BACK SKIP (21) or FORWARD SKIP BUTTON (29) to select a track you want to program.
- 4 Once you have selected a track, push the program button again. This stores the track into memory.
- 5 Use the BACK SKIP (21) or FORWARD SKIP BUTTON (29) to select the next track you want to program. Once selected, push the program button again.
- 6 Repeat step number 5 until you have programmed all desired tracks.
- 7 Push PLAY / PAUSE BUTTON (26) to begin playing the selected tracks. The program light will stop flashing and the selected tracks will begin playing. They will play in the order that they were programmed.
- 8 Using the BACK SKIP (21) or FORWARD SKIP BUTTON (29) will only skip through the programmed tracks.
- 9 To clear programmed tracks, push the stop button on the remote control twice until the program light goes out.
- 10 Programmed tracks will also be erased from memory when the CD DRAWER (12) is opened or when the power is turned off.

External Speakers

- 1 This radio is equipped with external speaker outputs.
- 2 The speaker jacks for external speakers are located on the back of the radio. Beside the speaker jacks is a switch labeled (int./ext.) When using external speakers, this switch must be switched to the ext. position. Doing this turns off the internal speakers in the radio and redirects to power to the external speakers.
- 3 If you decide not to use the external speakers, be sure the switch is on int. or the internal speakers will not work.

Auxiliary Inputs

- 1 You can connect external components to your unit by using the Auxiliary Inputs.
- 2 Plug Auxiliary cables (not supplied) into the INPUT JACK (18) on the back of your unit.
- 3 Switch the LINE IN ON/OFF (19) to the ON position.
- 4 Plug the other end of the Auxiliary cables into the output jack on your desired external component.
- 5 Check the volume level of your external component.
- 6 See operators manual for correct operation of the external component.

Power Source

- 1 Unwind the AC POWER CORD (17) at the back of the unit and connect it to a power outlet.
- 2 Plug A/C cord into appropriate outlet. **Note: This product may be equipped with a polarized alternating-current line plug (a plug having one blade wider than the other.) This plug will fit into the power outlet only one way. This is a safety feature. If you are unable to insert the plug fully into the outlet try reversing the plug, if the plug should still fail to fit, contact your electrician to replace your obsolete outlet. Do not defeat the safety purpose of the polarized plug.**
- 3 Install 2 AAA batteries (not included) in remote control.
- 4 Plug A/C cord into appropriate outlet.

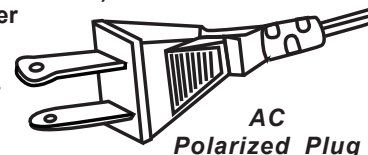

Troubleshooting

There's no sound?

- 1 Make sure the mute function is turned off.
- 2 Check that the volume is turned up by pressing vol. + button on remote.
- 3 Make sure ext. / int. switch on back of radio is on int. (unless you are using external speakers, in which case it should be on ext.)
- 4 Check to make sure power is turned on.

CD does not play?

- 1 Check to make sure CD is inserted correctly (label side facing up).
- 2 Check to see that surface of CD is clean.
- 3 Make sure radio is on CD function by pressing CD / Radio button.

Remote not working?

- 1 Replace batteries.
- 2 Be sure and point remote towards remote sensor when using.
- 3 Remove obstacles in the path of the remote and the radio so that remote signal has a straight path to the radio.

Bubble tubes not bubbling?

- 1 Make sure lights are on.
- 2 It takes approximately 15 to 20 minutes for the bubble tubes to warm up after the lights are on.
- 3 If the lights have been on at least 20 minutes and the tubes are still not bubbling, very lightly tap on the plastic at the bottom of the radio with your hand. Only tap very gently and never tap on the tube itself as it could case the tube to break.

IMPORTANT SAFETY INSTRUCTION

PLEASE READ CAREFULLY ALL THE FOLLOWING IMPORTANT SAFE GUARDS THAT ARE APPLICABLE TO YOUR EQUIPMENT

1. **Read Instructions** - All the safety and operating instructions should be read before the product is operated.
 2. **Retain instructions** - The safety and operating instructions should be retained for future reference.
 3. **Heed Warnings** - All warnings on the product and in the operating Instructions should be adhered to.
 4. **Follow Instructions** - All operating and use instructions should be followed.
 5. **Cleaning** - Unplug this product from the wall outlet before cleaning. Do not use liquid cleaners or aerosol cleaners. Use a damp cloth for cleaning.
 6. **Attachments** - Do not use attachments not recommended by the product manufacturer as they may cause hazards.
 7. **Water and Moisture** - Do not use this product near water - for example, near a bath tub, wash bowl, kitchen sink, or laundry tub; in a wet basement; or near a swimming pool; and the like.
 8. A product and cart combination should be moved with care. Quick stops, excessive force, and uneven surfaces may cause the product and cart combination to overturn.
 9. **Ventilation** - Slots and openings in the cabinet are provided for ventilation and to ensure reliable operation of the product and to protect it from overheating, and these openings must not be blocked or covered. The openings should never be blocked by placing the product on a bed, sofa, rug, or other similar surface. This product should not be placed in a built - in installation such as a bookcase or rack unless proper ventilation is provided or the manufacturer's instructions have been adhered to.
 10. **Power Sources** - This product should be operated only from the type of power source indicated on the marking label, if you are not sure of the type of power supply to your home. Consult your product dealer or local power company. For products intended to operate from battery power, or other sources, refer to the operating instructions.
 11. **Grounding or Polarization** - This product may be equipped with a polarized alternating-current line plug (a plug having one blade wider than the other). This plug will fit into the power outlet only one way. This is a safety feature. If you are unable to insert the plug fully into the outlet try reversing the plug. If the plug should still fail to fit, contact your electrician to replace your obsolete outlet. Do not defeat the safety purpose of the polarized plug.
 12. **Power - Cord Protection** - Power - supply cords should be routed so that they are not likely to be walked on or pinched by items placed upon or against them, paying particular attention to cords at plugs, convenience receptacles, and the point where they exit from the product.
 13. **Lightning** - For added protection for this product during a lightning storm, or when it is left unattended and unused for long periods of time, unplug it from the wall outlet and disconnect the antenna or cable system. This will prevent damage to the product due to lightning and power - line surges.
 14. **Power Lines** - An outside antenna system should not be located in the vicinity of overhead power lines or other electric light or power circuits, or where it can fall into such power lines or circuits. When installing an outside antenna system, extreme care should be taken to keep from touching such power lines or circuits as contact with them might be fatal.
 15. **Overloading** - Do not overload wall outlets, extension cords, or integral convenience receptacles as this can result in a risk of fire or electric shock.
 16. **Object and Liquid Entry** - Never push objects of any kind into this product through openings as they may touch dangerous voltage points or short - out parts that could result in a fire or electric shock. Never spill liquid of any kind on the product.
 17. **Servicing** - Do not attempt to service this product yourself as opening or removing covers may expose you to dangerous voltage or other hazards. Refer all servicing to qualified service personnel.
 18. **Damage Requiring Service** - Unplug this product from the wall outlet and refer servicing to qualified service personnel under the following conditions;
 - A. When the power-supply cord or plug is damaged.
 - B. If liquid has been spilled, or objects have fallen into the product.
 - C. If the product has been exposed to rain or water.
 - D. If the product does not operate normally by following the operating instructions. Adjust only those controls that are covered by the operating instructions as an improper adjustment of other controls may result in damage and will often require extensive work by a qualified technician to restore the product to its normal operation.
 - E. If the product has been dropped or damaged in any way.
 - F. When the product exhibits a distinct change in performance - this indicates a need for service.
 19. **Replacement Parts** - When replacement parts are required, be sure the service technician has used replacement parts specified by the manufacturer or have the same characteristics as the original part. Unauthorized substitutions may result in fire, electric shock, or other hazards.
 20. **Safety Check** - Upon completion of any service or repairs to this product, ask the service technician to perform safety checks to determine that the product is in proper operating condition.
 21. **Wall or ceiling Mounting** - The product should be mounted to a wall or ceiling only as recommended by the manufacturer.
 22. **Heat** - The product should be situated away from heat sources such as radiators. Heat registers, stoves, or other products (including amplifiers) that produce heat.
- WARNING:** Changes or modifications to this unit not expressly approved by the party responsible for compliance could void the user's authority to operate the equipment.
- NOTE:** This equipment has been tested and found to comply with the limits for a Class B digital device, pursuant to Part 15 of the FCC Rules. These limits are designed to provide reasonable protection against harmful interference in a residential installation. This equipment generates, uses, and can radiate radio frequency energy and, if not installed and used in accordance with the instructions, may cause harmful interference to radio communications. However, there is no guarantee that interference will not occur in a particular installation. If this equipment does cause harmful interference to radio or television reception, which can be determined by turning the equipment off and on, the user is encouraged to try to correct the interference by one or more of the following measures:
- Reorient or relocate the receiving antenna.
 - Increase the separation between the equipment and receiver.
 - Connect the equipment into an circuit different from that to which the receiver is connected.
 - Consult the dealer or an experienced radio TV technician for help.

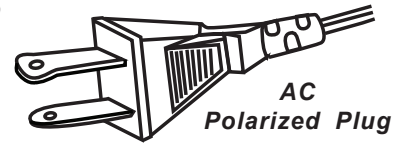

WARRANTY:

Free replacement of any part that fails within one year from day of manufacture, excluding shipping costs. Void if damaged by misuse, accidents, alterations, failure to follow instructions, fire, flood, and acts of God.

If you have any questions or comments, please contact your retailer.

BrandedProducts.com



Ace Product Management Group, Inc. Milwaukee, WI U.S.A
Manufactured under license from Harley-Davidson Motor Co.
© 2007 All Rights Reserved.

Ace Product Management Group, Inc.
Milwaukee, WI U.S.A.